

Motic[®]

555

SMZ-168 Series

1:6.7 Zoom Ratio Stereomicroscope



SMZ-168 STANDARD FEATURES

OPTICAL SYSTEM

- High Resolution Stereo Image
- Zoom Magnification Click Stops
- Standard Observation angle of 35°
SMZ-168-BL (60) Observation angle of 60°
- Diopter Adjustment on both eye tubes: ±5
- Adjustable interpupillary distance: 52mm - 75mm
SMZ-168-BL (60) Adjustable interpupillary distance: 52.5mm ~ 75mm
- Zoom Magnification Range: 0.75X - 5X
- Zoom Ratio: 1 : 6.7
- Working Distance: 113mm
- Anti-Fungus Properties



SMZ-168-BL
Binocular Stereomicroscope



SMZ-168-TL
Trinocular Stereomicroscope



SMZ-168-BL (60)
Binocular 60° Observation
Stereomicroscope

EYEPIECES

- Widefield High Eye Point 10X/23

FOCUSING BLOCK

- Ball bearing focusing mechanisms
- 50mm focusing range
- 76mm inner head mount
- 12V/10W Halogen incident light

BASE STAND

- Streamlined base stand
- Large working area
- 12V/10W Halogen transmitted light [intensity control]
- Universal power input 110V - 220V

SMZ-168 Series Advanced Zoom Stereo Microscopes Standard Configuration

	Order Number	SMZ-168BL	SMZ-168TP	SMZ-168TL
Binocular zoom body	AX66.02601	●		
Trinocular zoom body	AX68.02601		●	●
Head holder with incident light halogen 12V/10W (**works only with AX40.00002**)	AX66.02605A	●		●
Head holder without incident light	AX66.02605B		●	
Streamlined base stand	SW01.09K3		●	
Streamlined base stand with transmitted light halogen 12V/10W	AK40.00007	●		●

SMZ-168 SCHEMATIC DIAGRAM

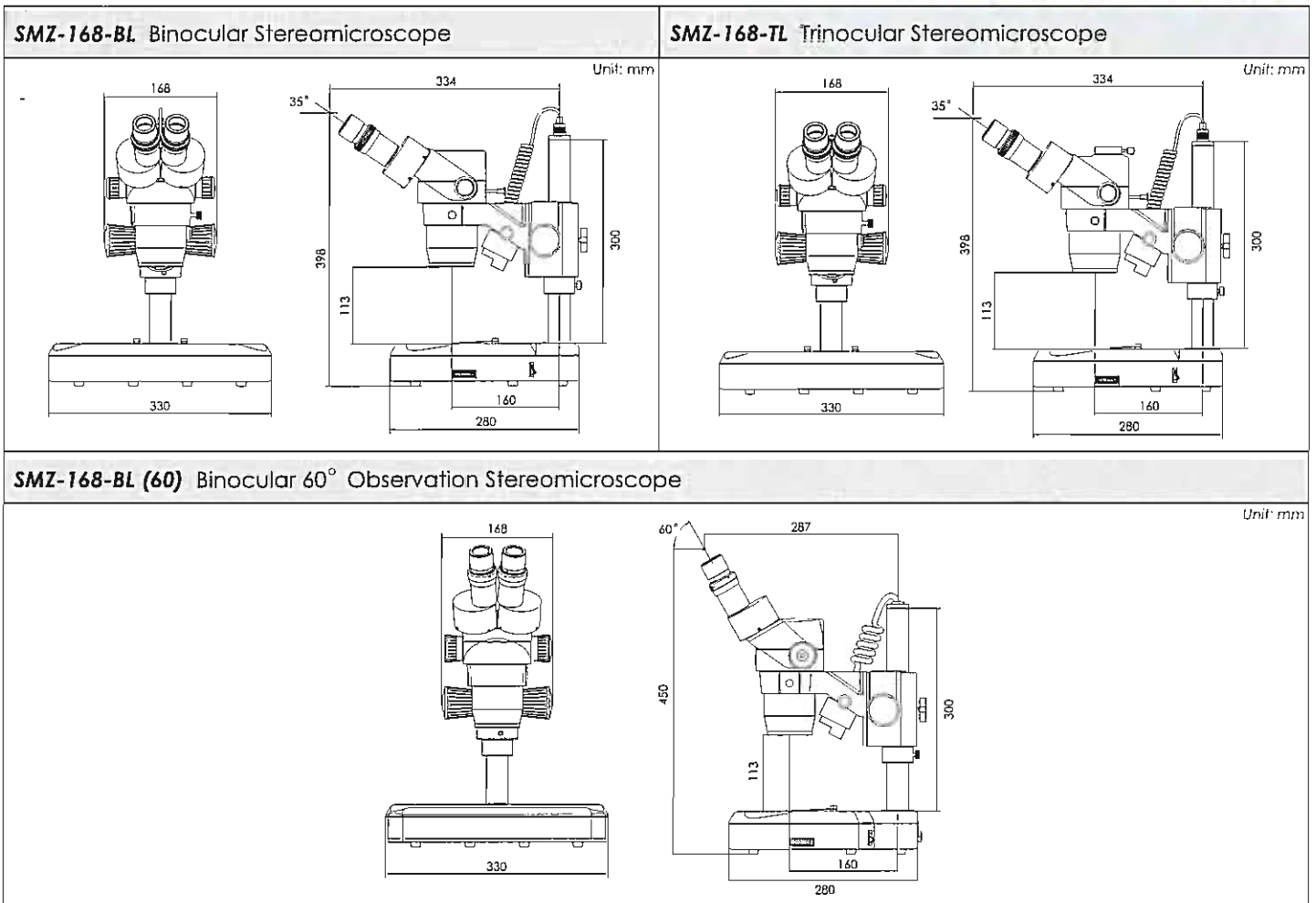

SMZ-168 SPECIFICATIONS

	SMZ-168 BL		SMZ-168 TL			SMZ-168 BL (60)	
Optical System	GREENOUGH						
Magnification Range	2.25X - 320X						
Zoom body magnification	0.75X - 5X						
Zoom Ratio	1 : 6.7						
Eyepieces	WF 10X/23 High eye point						
Interpupillary distance	52mm - 75mm						
Diopter adjustment	±5°						
Observation angle	35°				60°		
Working Distance	113mm						
Choice of eyepieces	5X/23	6.25X/23	10X/21	15X/17	20X/13	30X/8	32X/8
Additional objectives available	0.3X WD = 324mm 0.5X WD = 192mm 0.63X WD = 156mm 0.75X WD = 127mm 1.5X WD = 50 mm 2X WD = 34.5 mm						
Max. Magnification	320X						
Max. field of view	102 mm						
Max. working distance	324 mm						
Top light	12V / 10W Halogen [Reflected]						
Bottom Light	12V / 10W Halogen						
Photo and Video adapters	2X Photo Adapter 0.35x CCD Adapter [for 1/3" CCD] 0.65x CCD Adapter [for 1/2" CCD]						

CAMERA ADAPTERS

		
2X Photo Adapter 35mm SLR Camera AX6602603	0.35X CCD Adapter 1/3" CCD Camera AX6602602	0.65X CCD Adapter 1/2" CCD Camera SW0113R5

AUXILIARY OBJECTIVES

		
		
0.3X W.D. 324mm AX6602607	0.5X W.D. 192mm AX6602608	0.63X W.D. 156mm AX6602643
0.75X W.D. 127mm AX6602609	1.5X W.D. 50mm AX6602610	2X W.D. 34.5mm AX6602611

GLIDING STAGE

<ul style="list-style-type: none"> Base stand mountable Hand movable 360° rotatable for various observations 	 SW010308
---	--





MECHANICAL STAGE

<ul style="list-style-type: none"> Base stand mountable Max. X distance: 75mm Max. Y distance: 50mm Dimension in mm: 222.8(w) x 170(l) x 29.5(h) 	 SW010338K
--	---

EYEPIECES

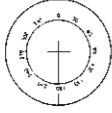
WF6.25X / 23mm	SG02T0103	
WF10X / 23mm	SG02T0218	
WF15X / 17mm	SG02T0318	
WF20X / 13mm	SG02T0406	
WF32X / 8mm	SG02T0502	

MEASURING EYEPIECES

			
360° : 10° [SG060314]	10mm:0.1mm [SG060312]	14mm : 0.2mm [SG060320]	14mm : 0.1mm [SG060315]

POLARISING EQUIPMENT

<ul style="list-style-type: none"> Base stand mountable 1-piece set 360° independently rotatable polariser [top] 360° independently rotatable analyser [bottom] 	 SP080013K
--	--

DARKFIELD ATTACHMENT

<ul style="list-style-type: none"> Conical glossy central stop for diffracted light observation Iris diaphragm for controlling the shape of light Base stand mountable 	 SP090001
---	--

POLARISING SET

<ul style="list-style-type: none"> Zoom body screw mount polariser Base stand mountable 360° rotatable analyser 	 AX6602633
---	---

JEWELLERY CLIP

<ul style="list-style-type: none"> Easily attachable for jewellery or mineral observation Movable upon attachment 	 SW0199B3
---	---

Eyepiece	Mag. (X)	Standard Objectives		Auxiliary Objectives											
				0.3X		0.5X		0.63X		0.75X		1.5X		2X	
		WD 113mm		WD 324mm		WD 192mm		WD 156mm		WD 127mm		WD 50mm		WD 34.5mm	
		Mag.	FD (mm)	Mag.	FD (mm)	Mag.	FD (mm)	Mag.	FD (mm)	Mag.	FD (mm)	Mag.	FD (mm)	Mag.	FD (mm)
5X/23	0.75	3.8	30.7	1.1	102.2	1.9	61.3	2.4	48.7	2.8	40.9	5.6	20.4	7.5	15.3
	1	5.0	23.0	1.5	76.7	2.5	46.0	3.2	36.5	3.8	30.7	7.5	15.3	10.0	11.5
	2	10.0	11.5	3.0	38.3	5.0	23.0	6.3	18.3	7.5	15.3	15.0	7.7	20.0	5.8
	3	15.0	7.7	4.5	25.6	7.5	15.3	9.5	12.2	11.3	10.2	22.5	5.1	30.0	3.8
	4	20.0	5.8	6.0	19.2	10.0	11.5	12.6	9.1	15.0	7.7	30.0	3.8	40.0	2.9
	5	25.0	4.6	7.5	15.3	12.5	9.2	15.8	7.3	18.8	6.1	37.5	3.1	50.0	2.3
6.25X/23	0.75	4.7	30.7	1.4	102.2	2.3	61.3	3.0	48.7	3.5	40.9	7.0	20.4	9.4	15.3
	1	6.3	23.0	1.9	76.7	3.1	46.0	3.9	36.5	4.7	30.7	9.4	15.3	12.5	11.5
	2	12.5	11.5	3.8	38.3	6.3	23.0	7.9	18.3	9.4	15.3	18.8	7.7	25.0	5.8
	3	18.8	7.7	5.6	25.6	9.4	15.3	11.8	12.2	14.1	10.2	28.1	5.1	37.5	3.8
	4	25.0	5.8	7.5	19.2	12.5	11.5	15.8	9.1	18.8	7.7	37.5	3.8	50.0	2.9
	5	31.3	4.6	9.4	15.3	15.6	9.2	19.7	7.3	23.4	6.1	46.9	3.1	62.5	2.3
10X/23	0.75	7.5	30.7	2.3	102.2	3.8	61.3	4.7	48.7	5.6	40.9	11.3	20.4	15.0	15.3
	1	10.0	23.0	3.0	76.7	5.0	46.0	6.3	36.5	7.5	30.7	15.0	15.3	20.0	11.5
	2	20.0	11.5	6.0	38.3	10.0	23.0	12.6	18.3	15.0	15.3	30.0	7.7	40.0	5.8
	3	30.0	7.7	9.0	25.6	15.0	15.3	18.9	12.2	22.5	10.2	45.0	5.1	60.0	3.8
	4	40.0	5.8	12.0	19.2	20.0	11.5	25.2	9.1	30.0	7.7	60.0	3.8	80.0	2.9
	5	50.0	4.6	15.0	15.3	25.0	9.2	31.5	7.3	37.5	6.1	75.0	3.1	100.0	2.3
10X/21	0.75	7.5	28.0	2.3	93.3	3.8	56.0	4.7	44.4	5.6	37.3	11.3	18.7	15.0	14.0
	1	10.0	21.0	3.0	70.0	5.0	42.0	6.3	33.3	7.5	28.0	15.0	14.0	20.0	10.5
	2	20.0	10.5	6.0	35.0	10.0	21.0	12.6	16.7	15.0	14.0	30.0	7.0	40.0	5.3
	3	30.0	7.0	9.0	23.3	15.0	14.0	18.9	11.1	22.5	9.3	45.0	4.7	60.0	3.5
	4	40.0	5.3	12.0	17.5	20.0	10.5	25.2	8.3	30.0	7.0	60.0	3.5	80.0	2.6
	5	50.0	4.2	15.0	14.0	25.0	8.4	31.5	6.7	37.5	5.6	75.0	2.8	100.0	2.1
15X/17	0.75	11.3	22.7	3.4	75.6	5.6	45.3	7.1	36.0	8.4	30.2	16.9	15.1	22.5	11.3
	1	15.0	17.0	4.5	56.7	7.5	34.0	9.5	27.0	11.3	22.7	22.5	11.3	30.0	8.5
	2	30.0	8.5	9.0	28.3	15.0	17.0	18.9	13.5	22.5	11.3	45.0	5.7	60.0	4.3
	3	45.0	5.7	13.5	18.9	22.5	11.3	28.4	9.0	33.8	7.6	67.5	3.8	90.0	2.8
	4	60.0	4.3	18.0	14.2	30.0	8.5	37.8	6.7	45.0	5.7	90.0	2.8	120.0	2.1
	5	75.0	3.4	22.5	11.3	37.5	6.8	47.3	5.4	56.3	4.5	112.5	2.3	150.0	1.7
20X/13	0.75	15.0	17.3	4.5	57.8	7.5	34.7	9.5	27.5	11.3	23.1	22.5	11.6	30.0	8.7
	1	20.0	13.0	6.0	43.3	10.0	26.0	12.6	20.6	15.0	17.3	30.0	8.7	40.0	6.5
	2	40.0	6.5	12.0	21.7	20.0	13.0	25.2	10.3	30.0	8.7	60.0	4.3	80.0	3.3
	3	60.0	4.3	18.0	14.4	30.0	8.7	37.8	6.9	45.0	5.8	90.0	2.9	120.0	2.2
	4	80.0	3.3	24.0	10.8	40.0	6.5	50.4	5.2	60.0	4.3	120.0	2.2	160.0	1.6
	5	100.0	2.6	30.0	8.7	50.0	5.2	63.0	4.1	75.0	3.5	150.0	1.7	200.0	1.3
30X/8	0.75	22.5	10.7	6.8	35.6	11.3	21.3	14.2	16.9	16.9	14.2	33.8	7.1	45.0	5.3
	1	30.0	8.0	9.0	26.7	15.0	16.0	18.9	12.7	22.5	10.7	45.0	5.3	60.0	4.0
	2	60.0	4.0	18.0	13.3	30.0	8.0	37.8	6.3	45.0	5.3	90.0	2.7	120.0	2.0
	3	90.0	2.7	27.0	8.9	45.0	5.3	56.7	4.2	67.5	3.6	135.0	1.8	180.0	1.3
	4	120.0	2.0	36.0	6.7	60.0	4.0	75.6	3.2	90.0	2.7	180.0	1.3	240.0	1.0
	5	150.0	1.6	45.0	5.3	75.0	3.2	94.5	2.5	112.5	2.1	225.0	1.1	300.0	0.8
32X/8	0.75	24.0	10.7	7.2	35.6	12.0	21.3	15.1	16.9	18.0	14.2	36.0	7.1	48.0	5.3
	1	32.0	8.0	9.6	26.7	16.0	16.0	20.2	12.7	24.0	10.7	48.0	5.3	64.0	4.0
	2	64.0	4.0	19.2	13.3	32.0	8.0	40.3	6.3	48.0	5.3	96.0	2.7	128.0	2.0
	3	96.0	2.7	28.8	8.9	48.0	5.3	60.5	4.2	72.0	3.6	144.0	1.8	192.0	1.3
	4	128.0	2.0	38.4	6.7	64.0	4.0	80.6	3.2	96.0	2.7	192.0	1.3	256.0	1.0
	5	160.0	1.6	48.0	5.3	80.0	3.2	100.8	2.5	120.0	2.1	240.0	1.1	320.0	0.8

Note : "WD" represents Working Distance, "Mag." represents Magnification, "FD" represents Field Diameter.

K2401 FLUORESCENT RING ILLUMINATOR

- Colour Temperature: 6400K
- Even white light
- 12W power consumption
- Specifically designed attachment for SMZ-168



MLG-150 COLD LIGHT SOURCE

- Colour Temperature Indication
- Colour Temperature Range: 2500K - 3200K
- Remote or local intensity control
- 21V / 150W switching power
- Filter holder



LIGHT GUIDE OPTIONS



Flexible ring light guide
SP990074



1 Arm gooseneck type light guide
SP990075



2 Arm gooseneck type light guide
SP990076

SMZ-168 SERIES CHOICE OF BASE STANDS

Universal Stand



- Diameter of base 380mm
- Diameter of vertical pole 25mm
- Height of pole 200mm
- Diameter of pole for focusing mount 32mm

Special Universal Stand



- Length of base 250mm
- Height of pole 373mm
- Width of base 250mm
- Diameter of pole for focusing mount 32mm

Ball Bearing Boom Stand



- Diameter of vertical pole 36mm
- Diameter of pole for focusing mount 32mm

Ball Bearing Boom Stand



- Diameter of vertical pole 36mm
- Diameter of pole for focusing mount 32mm

Articulating Arm Boom Stand



- Diameter of vertical pole 36mm
- Diameter of pole for focusing mount 32mm

Articulating Arm Boom Stand



- Diameter of vertical pole 36mm
- Diameter of pole for focusing mount 32mm

SMZ-168 SERIES SYSTEM DIAGRAM

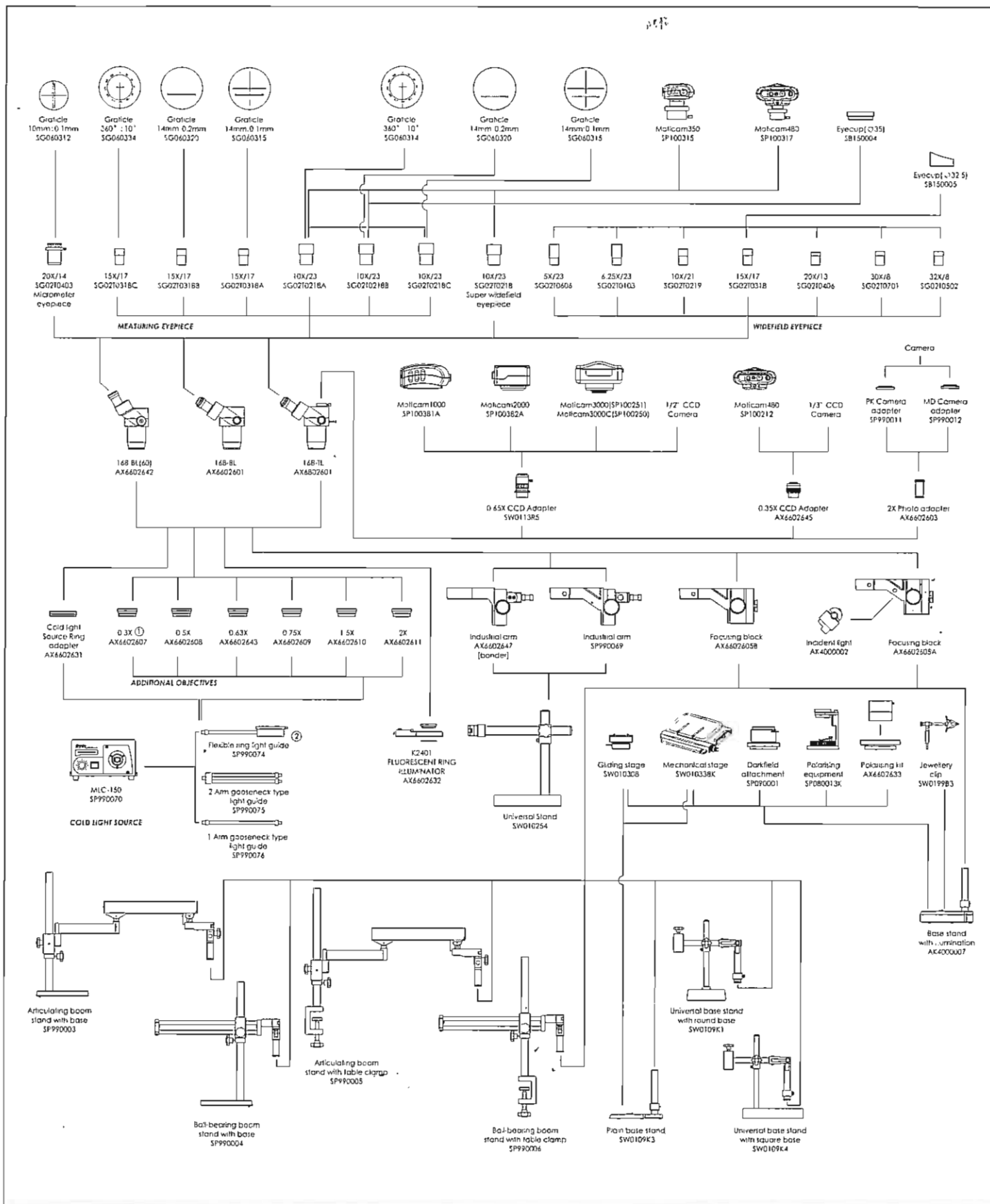

① Special long pole of 450mm required to use with 0.3X objective.

② When using the cold light source ring light guide, you need to select item number AX6602631 for proper fit

* When selecting the fluorescent ring illuminator, please note the country plug and voltage required.